



19011102A01

1. Overview

Thank you for purchasing the GL10-0016ETN digital output module developed by Inovance.

The GL10-0016ETN is an NPN output module and is used together with AM600CPU, GL10-RTU-ECT, GL10-RTU-COP, GL10-RTU-DP and H3U.

This manual contains basic information such as specifications, characteristics and usage of the product. Read this manual carefully to ensure correct and safe use. Keep this manual well and forward it to the end user.

2. Safety Information and Precautions

WARNING A Warning contains information, which is essential for avoiding a safety hazard.

CAUTION A Caution contains information, which is necessary for avoiding a risk of damage to the product or other machine.

Design

- WARNING**
 - Installation must be carried out by personnel who have the necessary electrical training and experience.
 - Disconnect all external power supplies of the system before removing/installing the module. Failure to comply may result in electric shock, module fault or malfunction.
 - Install the PLC in the place free from dust, oil smoke, conductive dust, corrosive or combustible gases, high temperature, condensation, wind & rain, vibration and shock. Electric shock, fire and malfunction may also result in damage or deterioration to the product.
 - The PLC is an open-type must be installed in a control cabinet with lock (cabinet housing must satisfy protection of over IP20). Only the personnel who have the necessary electrical training and experience can open the cabinet.

- CAUTION**
 - Prevent dropping metal filings and wire ends drop into ventilation holes of the PLC during installation. Failure to comply may result in fire, fault and malfunction.
 - Ensure there are no foreign matters on ventilation surface. Failure to comply may result in poor ventilation, which may cause fire, fault and malfunction.
 - Ensure the module is connected to the respective connector securely and hook the module firmly. Improper installation may result in malfunction, fault or fall-off.

Installation

- WARNING**
 - Installation must be carried out by the specialists who have received the necessary electrical training and understood enough electrical knowledge.
 - Disconnect all external power supplies of the system before removing/installing the module. Failure to do so may result in electric shock, module fault or malfunction.
 - Do not use the PLC where there are dust, oil smoke, conductive dust, corrosive or combustible gases, or exposed to high temperature, condensation, wind & rain, or subject to vibration and impact. Electric shock, fire and malfunction may also result in damage or deterioration to the product.
 - The PLC is open-type equipment that must be installed in a control cabinet with lock (cabinet housing protection >IP20). Only the personnel who have received the necessary electrical training and understood enough electrical knowledge can open the cabinet.

- CAUTION**
 - Prevent metal filings and wire ends from dropping into ventilation holes of the PLC during installation. Failure to comply may result in fire, fault and malfunction.
 - Ensure there are no foreign matters on ventilation surface. Failure to comply may result in poor ventilation, which may cause fire, fault and malfunction.
 - Ensure the module is connected to the respective connector securely and hook the module firmly. Improper installation may result in malfunction, fault or fall-off.

Wiring

- WARNING**
 - Wiring must be carried out by personnel who have the necessary electrical training and experience.
 - Disconnect all external power supplies of the system before wiring. Failure to comply may result in electric shock, module fault or malfunction.
 - Install the terminal cover attached to the product before power-on or operation after wiring is completed. Failure to comply may result in electric shock.
 - Perform good insulation on terminals so that insulation distance between cables will not reduce after cables are connected to terminals. Failure to comply may result in electric shock or damage to the equipment.

- CAUTION**
 - Prevent dropping metal filings and wire ends drop into ventilation holes of the PLC at wiring. Failure to comply may result in fire, fault and malfunction.
 - The external wiring specification and installation method must comply with local regulations. For details, see the wiring section in this manual.
 - To ensure safety of equipment and operator, use cables with sufficient diameter and connect the cables to ground reliably.
 - Wire the module correctly after making clear of the connector type. Failure to comply may result in module and external equipment fault.
 - Tighten terminals in the specified torque range. If the terminal is not tight, short-circuit, fire or malfunction may be caused. If the terminal is too tight, fall-off, short-circuit, fire or malfunction may be caused.
 - If connector is used to connect with external equipment, perform correct crimping or welding with the tool specified by manufacturer. If connection is in poor contact, short-circuit, fire or malfunction may be caused.
 - A label on the top of the module is to prevent foreign matters entering the module. Do not remove the lable during wiring. But remember to remove it before system operation, facilitating ventilation.
 - Do not bundle control wires, communication wires and power cables together. They must be run with distance of more than 100 mm. Otherwise, noise may result in malfunction.
 - Select shielded cable for high-frequency signal output/output in applications with serious interference so as to enhance system anti-interference ability.

Maintenance & Inspection

- WARNING**
 - Maintenance & inspection must be carried out by personnel who have the necessary electrical training and experience.
 - Do not touch the terminals while the power is on. Failure to comply may result in electric shock or malfunction.
 - Disconnect all external power supplies of the system before cleaning the module or re-tightening screws on the terminal block or screws of the connector. Failure to comply may result in electric shock.
 - Disconnect all external power supplies of the system before removing the module or connecting/removing the communication wirings. Failure to comply may result in electric shock or malfunction.

- CAUTION**
 - Read the guide carefully and ensure safety before online modification, forcible output, and RUN/STOP operation.
 - Disconnect the power supply before installing/removing the extension card.

Disposal

- CAUTION**
 - Treat scrapped module as industrial waste. Dispose the battery according to local laws and regulations.
 - Get acquainted with the manual and ensure safety before online modification, forcible output, and RUN/STOP operation.
 - Disconnect the power supply before installing/removing the extension card.

3. Product Information

Product Type Identification

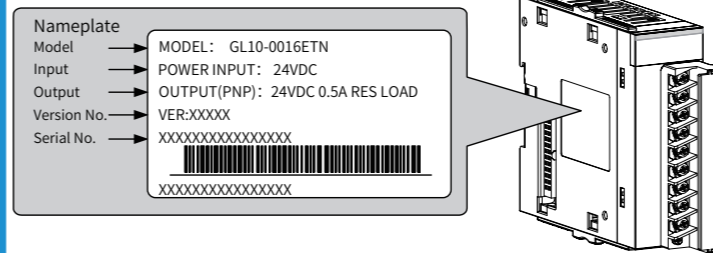
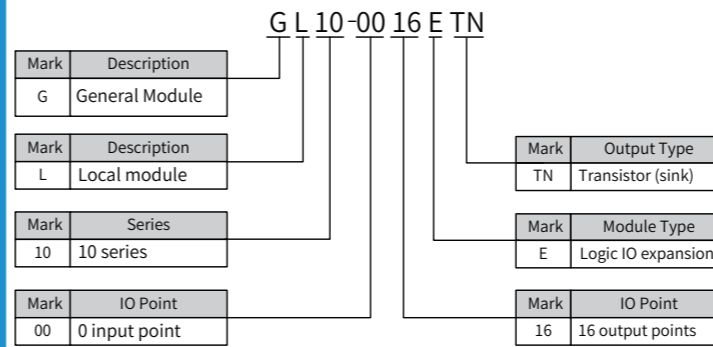

Model	Classification	Description	Applicable Model
GL10-0016ETN	Digital output module	16-channel DO module: transistor output (SINK)	AM600 series, H3U

External Interfaces

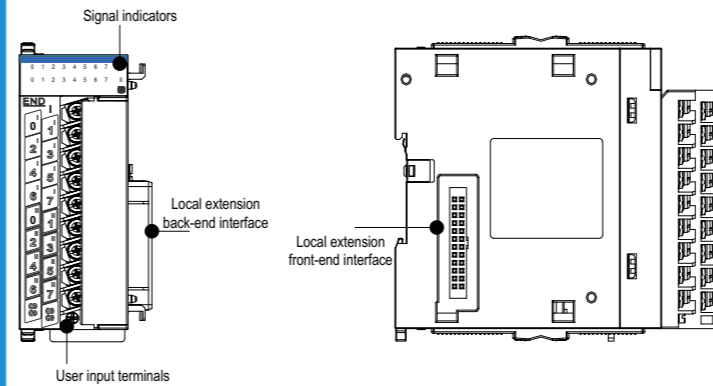

Interface Name	Function
User output terminal	8-channel outputs x 2
Signal indicators	Corresponding to various output signal ON: output active OFF: output inactive
Local expansion module back-end interface	Connect back-end module, not supporting hot plugging
Local expansion module front-end interface	Connect front-end module, not supporting hot plugging

Specifications

Item	Specifications	
Output channel	16	
Output connecting mode	18-point wiring terminal	
Output type	Transistor output	
Power voltage	24 VDC (-15% to 20%)	
Output voltage class	12 to 24 V (-5% to 20%)	
Internal 5 V power consumption	110 mA (typical value)	
OFF max. leakage current	0.5 mA below	
ON response time	0.5 ms below (hardware response time)	
OFF response time	0.5 ms below (hardware response time)	
Max. load	Resistive load	0.5 A/point, 2 A/common
	Inductive load	12 W/24 VDC (total)
	Lamp load	2 W/24 VDC (total)
Isolation method	Opto-couplers isolation for opto-coupler drive	
Output action display	Output indicator ON	
Preventing short-circuit output	No	

4. Mechanical Design Reference

Mounting Dimensions

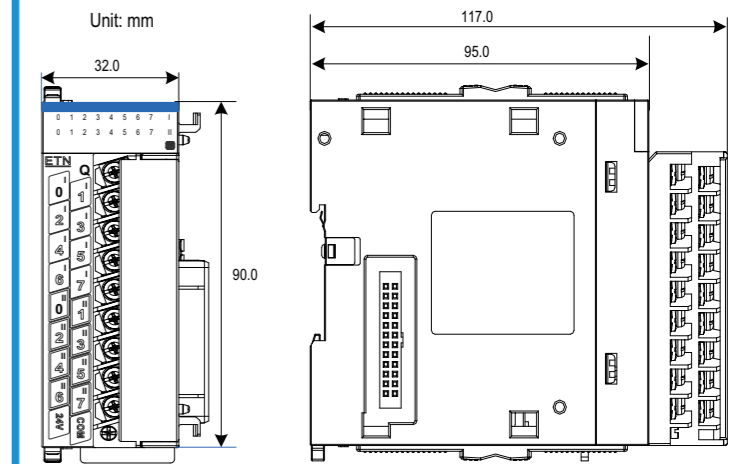

5. Electrical Design Reference

Cable Selection

Cable Name	Model	Applicable Cable Diameter		Manufacturer	Crimping Tool
		mm ²	AWG		
Y-type cable lug	TNS1.25-3	0.5-0.75	22-18	Suzhou Yuanli	RYO-8, YYT-8

Cable Preparing

- Strip back the wire outer coating by 6 mm.
- Pass the cable through the tube of proper wire size.
- Insert the exposed end into the hole of the cable lug, and then crimp it with recommended crimping tool.
- Use heat-shrinkable tube (Φ3) of 20 mm long to wrap the copper tube of the cable lug and then perform thermal shrinkage.

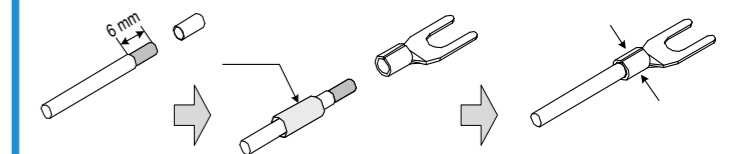

- Put the cable lug onto the terminal and tighten the screw with a screwdriver. The maximum tightening torque is 0.8 N.m.

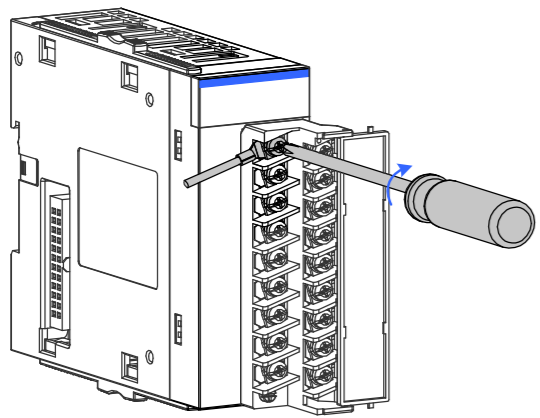

Terminals Arrangement

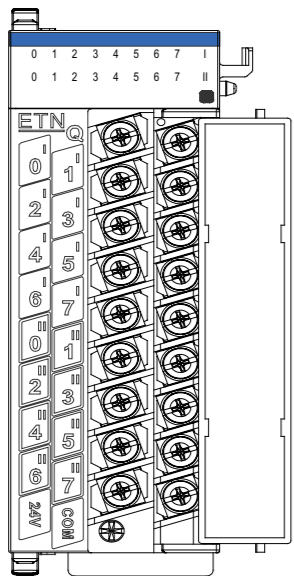

Terminal Definition

SN	Network Name	Type	Function	Remark
The 1st Group of Output Interfaces				
1	Q0	Output	The 1st group of user output 0	SINK, transistor output
2	Q1	Output	The 1st group of user output 1	SINK, transistor output
3	Q2	Output	The 1st group of user output 2	SINK, transistor output
4	Q3	Output	The 1st group of user output 3	SINK, transistor output
5	Q4	Output	The 1st group of user output 4	SINK, transistor output
6	Q5	Output	The 1st group of user output 5	SINK, transistor output
7	Q6	Output	The 1st group of user output 6	SINK, transistor output
8	Q7	Output	The 1st group of user output 7	SINK, transistor output
The 2nd Group of Output Interfaces				
9	Q0	Output	The 2nd group of user output 0	SINK, transistor output
10	Q1	Output	The 2nd group of user output 1	SINK, transistor output
11	Q2	Output	The 2nd group of user output 2	SINK, transistor output
12	Q3	Output	The 2nd group of user output 3	SINK, transistor output
13	Q4	Output	The 2nd group of user output 4	SINK, transistor output
14	Q5	Output	The 2nd group of user output 5	SINK, transistor output
15	Q6	Output	The 2nd group of user output 6	SINK, transistor output
16	Q7	Output	The 2nd group of user output 7	SINK, transistor output
Common				
17	24V	Power	24 V pover supply	24VDC power output
18	COM	Power	Power ground	24VDC power common

External Wiring

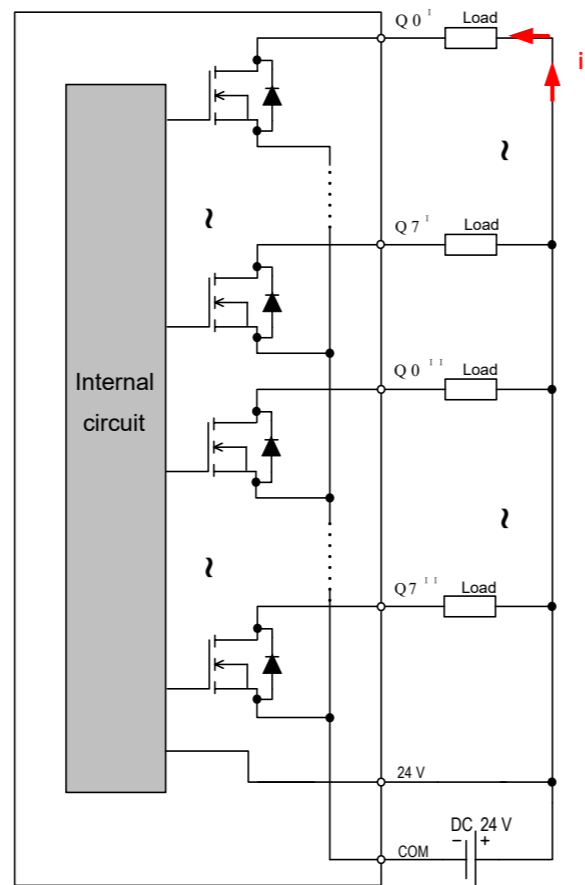

Wiring Precautions

Do not bundle the extension cable together with power cables (high voltage, large current) which produce strong interference signals. Separate it from other cables and avoid cabling in parallel.

It is recommended that shielded cable is used as extension cable to enhance capacity of resisting interference. Use pinboard to connect the extension cable.

Contact Protection When Using Inductive Load

When inductive load is applied, large back EMF will be produced between contacts and arc discharge is also caused when inductive load stops. This may result in contact failure or contact sag, shortening the contact lifetime. Thus, connect a freewheel diode in parallel if necessary to extend the contact lifetime.

The freewheel diode must satisfy: 1) reverse voltage is 5 to 10 times of load voltage; 2) forward current is larger than load current.

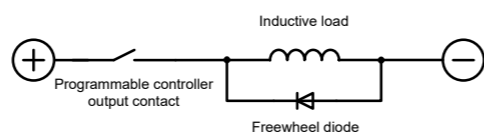

6. Programming Examples

AM600+GL10-0016ETN Programming Example

Use AM600CPU as main control module and set the first channel of two groups of outputs of the GL10-0016ETN to active.

- 1) Create a new project and perform hardware configuration as follows:

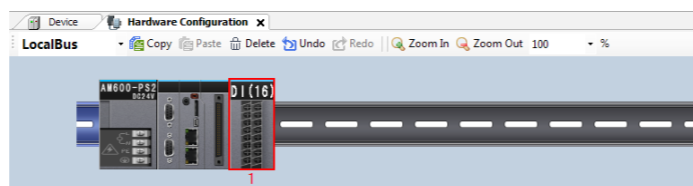

- 2) Use ST programming language to program the GL10-0016ETN module, define the mapping variable of the first channel of each group of outputs as Q1_0 and Q2_0, and set corresponding channel of mapping variable to active.

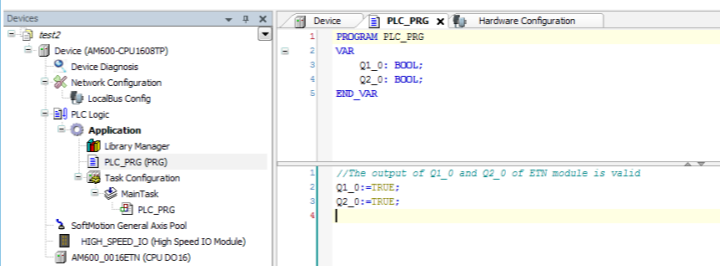

- 3) Map the mapping variables Q1_0 and Q2_0 defined in the program to the first channel of two groups of outputs of the GL10-1600ETN respectively, shown in the following figure.

Variable	Mapping	Channel	Address	Type	Unit	Description
Application.PLC_PRG.Q1_0	Q1	QB(1)	%QB1	USINT		
	Q0	%QB1.0		BOOL		
	Q1	%QB1.1		BOOL		
	Q2	%QB1.2		BOOL		
	Q3	%QB1.3		BOOL		
	Q4	%QB1.4		BOOL		
	Q5	%QB1.5		BOOL		
	Q6	%QB1.6		BOOL		
	Q7	%QB1.7		BOOL		
Application.PLC_PRG.Q2_0	Q0	QB(2)	%QB2	USINT		
	Q1	%QB2.0		BOOL		
	Q2	%QB2.1		BOOL		
	Q2	%QB2.2		BOOL		

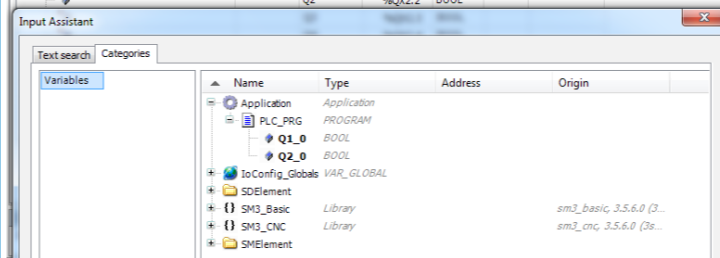

- 4) After compiling succeeds, download the project and start operation.

H3U + AM600-0016ETN Programming Example

Use H3U as main control module and set the first channel of the GL10-0016ETN to active.

- 1) Create a new project and select "H3U". Then the system enters the main page.
- 2) Double click "Module config". Then the H3U simulated diagram is displayed as below:

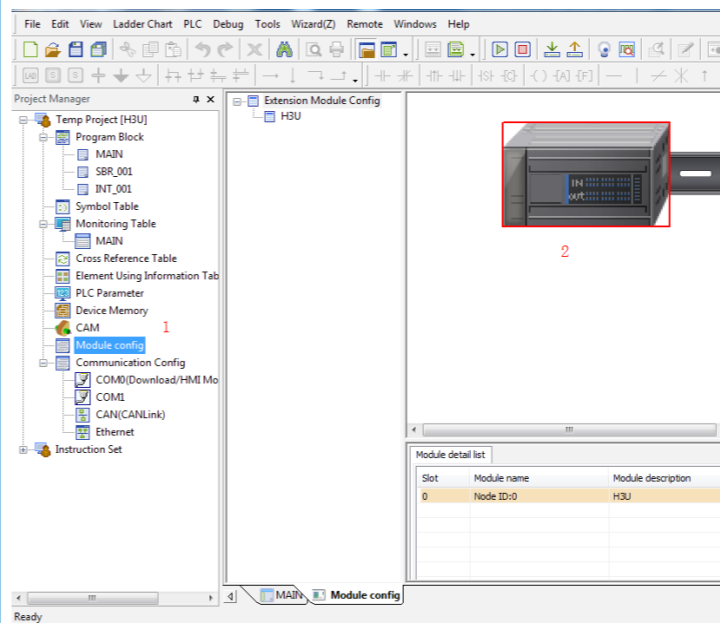

- 3) In the module list, select the module GL10-0016ETN to be added. You can double-click the module for extension automatically or drag the module onto the extension rack by holding the left mouse button.

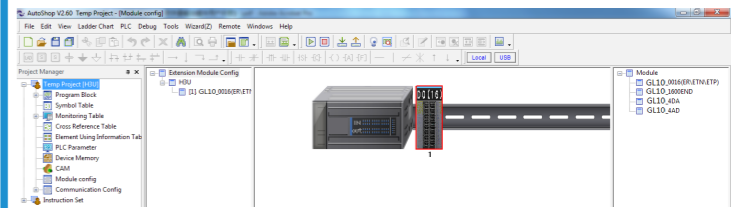

- 4) Perform programming on outputs of the GL10-0016ETN by using ladder diagram.

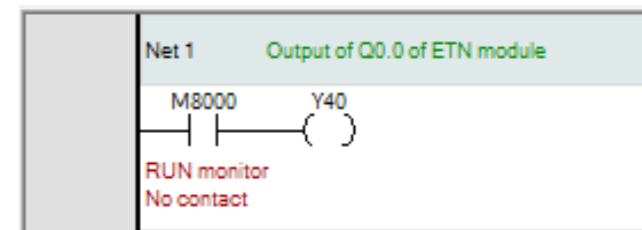

Note:

- ◆ Y indicates bit component of control output of the PLC. When local expansion module is connected to the H3U, SN of the Y port on expansion module follows that of the Y port on the main module. For example, main module H3U-3232MT connects the GL10-1600ER. SN of the last Y port of the main module is Y37. SNs of Y ports of the expansion module are Y40 to Y57.
 - ◆ SN of Y ports of the expansion module starts from units position 0 in octonary system.
- 5) After compiling succeeds, download the project and start operation.

INOVANCE Warranty Agreement

- 1) Inovance provides an 18-month free warranty to the equipment itself from the date of manufacturing for the failure or damage under normal use conditions.
- 2) Within the warranty period, maintenance will be charged for the damage caused by the following reasons:
 - a. Improper use or repair/modification without prior permission
 - b. Fire, flood, abnormal voltage, natural disasters and secondary disasters
 - c. Hardware damage caused by dropping or transportation after procurement
 - d. Operations not following the user instructions
 - e. Damage out of the equipment (for example, external device factors)
- 3) The maintenance fee is charged according to the latest Maintenance Price List of Inovance.
- 4) If there is any problem during the service, contact Inovance's agent or Inovance directly.
- 5) Inovance reserves the rights for explanation of this agreement.

Suzhou Inovance Technology Co., Ltd.

Address: No.16, Youxiang Road, Yuexi Town, Wuzhong District, Suzhou 215104, P.R. China

Website: <http://www.inovance.com>